

TOSHIBA Photocoupler GaAs Ired & Photo-Thyristor

TLP541G, TLP542G

Programmable Controllers

AC-Output Module

Solid State Relay

The TOSHIBA TLP541G consists of a photo-thyristor optically coupled to a gallium arsenide infrared emitting diode in a six lead plastic DIP package.

The TOSHIBA TLP542G consists of a photo-thyristor optically coupled to a gallium arsenide infrared emitting diode in a seven lead plastic DIP package.

- Peak off-state voltage: 400 V (min.)
- Trigger LED current: 7 mA (max.)
- On-state current: 150 mA (max.)
- Isolation voltage: 2500 V_{rms} (min.)
- UL recognized: UL1577, file no. E67349

Pin Configuration (top view)

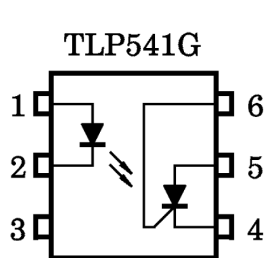

- TLP541G**
- 1 : ANODE
 - 2 : CATHODE
 - 3 : N.C.
 - 4 : CATHODE
 - 5 : ANODE
 - 6 : GATE

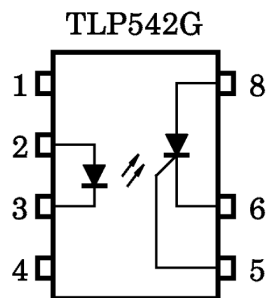

- TLP542G**
- 1 : N.C.
 - 2 : ANODE
 - 3 : CATHODE
 - 4 : N.C.
 - 5 : GATE
 - 6 : CATHODE
 - 7 : ANODE

Unit in mm

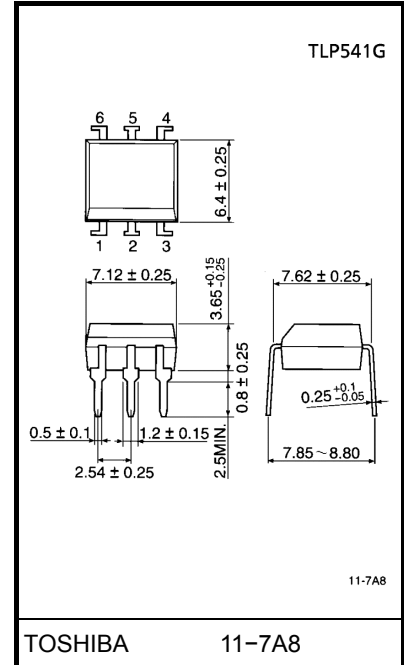

TOSHIBA 11-7A8

Weight: 0.4 g

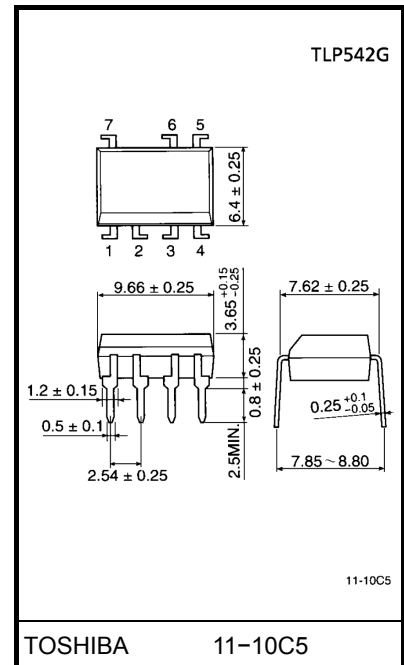

TOSHIBA 11-10C5

Weight: 0.53 g

Maximum Ratings (Ta = 25°C)

Characteristic		Symbol	Rating	Unit
LED	Forward current	I_F	70	mA
	Forward current derating (Ta ≥ 25°C)	$\Delta I_F / ^\circ\text{C}$	-0.7	mA / °C
	Peak forward current (100 μs pulse, 100 pps)	I_{FP}	1	A
	Reverse voltage	V_R	5	V
	Junction temperature	T_j	125	°C
Detector	Peak forward voltage (RGK = 27kΩ)	V_{DRM}	400	V
	Peak reverse voltage (RGK = 27kΩ)	V_{RRM}	400	V
	On-state current	I_T (RMS)	150	mA
	On-state current derating (Ta ≥ 25°C)	$\Delta I_T / ^\circ\text{C}$	-2.0	mA / °C
	Peak one cycle surge current	I_{TSM}	2	A
	Peak reverse gate voltage	V_{GM}	-5	V
	Junction temperature	T_j	100	°C
Storage temperature range		T_{stg}	-55~125	°C
Operating temperature range		T_{opr}	-30~100	°C
Lead soldering temperature (10 s)		T_{sol}	260	°C
Isolation voltage (AC, 1 min., R.H. ≤ 60%) (Note)		BV_S	2500	V_{rms}

(Note) Device considered a two terminal device: LED side pins shorted together and detector side pins shorted together.

Recommended Operating Conditions

Characteristic	Symbol	Min.	Typ.	Max.	Unit
Supply voltage	V_{AC}	—	—	120	V_{ac}
Forward current	I_F	10	16	25	mA
Operating temperature	T_{opr}	-30	—	85	°C
Gate to cathode resistance	R_{GK}	—	27	33	kΩ
Gate to cathode capacity	C_{GK}	—	0.01	0.1	μF

Individual Electrical Characteristics (Ta = 25°C)

Characteristic		Symbol	Test Condition	Min.	Typ.	Max.	Unit	
LED	Forward voltage	V_F	$I_F = 10 \text{ mA}$	1.0	1.15	1.3	V	
	Reverse current	I_R	$V_R = 5 \text{ V}$	—	—	10	μA	
	Capacitance	C_T	$V = 0, f = 1 \text{ MHz}$	—	30	—	pF	
Detector	Off-state current	I_{DRM}	$V_{AK} = 400 \text{ V}$ $R_{GK} = 27 \text{ k}\Omega$	Ta = 25°C	—	10	5000	nA
				Ta = 100°C	—	1	100	μA
	Reverse current	I_{RRM}	$V_{KA} = 400 \text{ V}$ $R_{GK} = 27 \text{ k}\Omega$	Ta = 25°C	—	10	5000	nA
				Ta = 100°C	—	1	100	μA
	On-state voltage	V_{TM}	$I_{TM} = 100 \text{ mA}$	—	0.9	1.3	V	
	Holding current	I_H	$R_{GK} = 27 \text{ k}\Omega$	—	0.2	1	mA	
	Off-state dv/dt	dv/dt	$V_{AK} = 280 \text{ V}, R_{GK} = 27 \text{ k}\Omega$	5	10	—	V/ μs	
Capacitance	C_j	$V = 0, f = 1 \text{ MHz}$	Anode to gate	—	20	—	pF	
			Gate to cathode	—	350	—		

Coupled Characteristics (Ta = 25°C)

Characteristic	Symbol	Test Condition	Min.	Typ.	Max.	Unit
Trigger LED current	I_{FT}	$V_{AK} = 6 \text{ V}, R_{GK} = 27 \text{ k}\Omega$	1	4	7	mA
Turn-on time	t_{on}	$I_F = 50 \text{ mA}, R_{GK} = 27 \text{ k}\Omega$	—	10	—	μs
Capacitance (input to output)	C_S	$V_S = 0, f = 1 \text{ MHz}$	—	0.8	—	pF
Isolation resistance	R_S	$V_S = 500 \text{ V}, \text{R.H.} \leq 60\%$	—	10^{11}	—	Ω
Isolation voltage	BV_S	AC, 1 minute	2500	—	—	V_{rms}

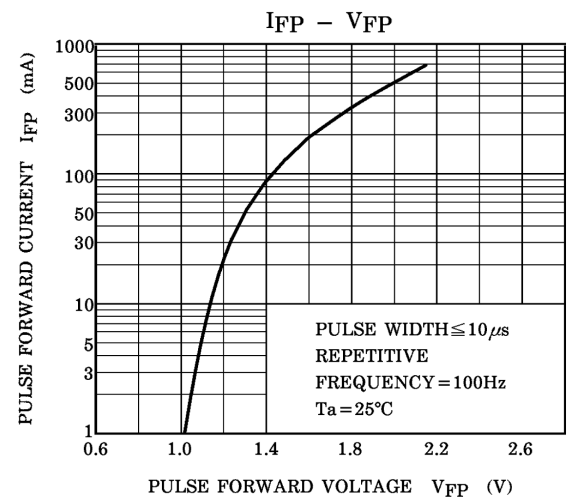
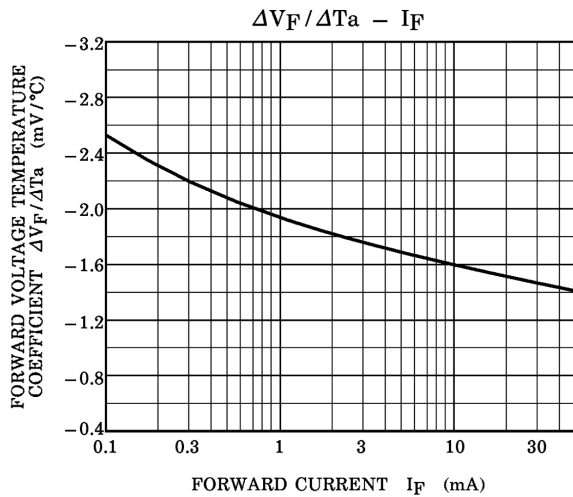
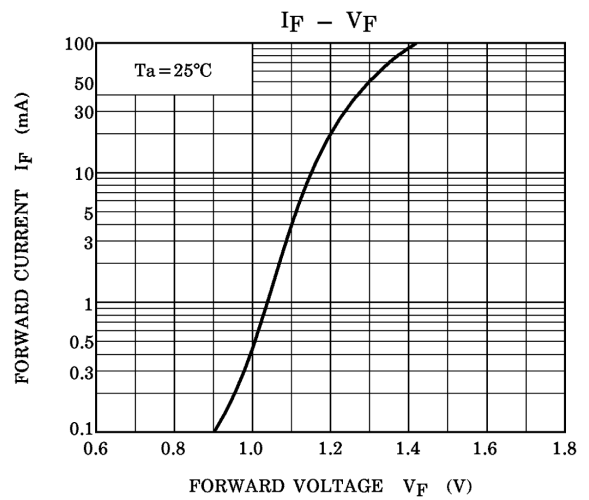
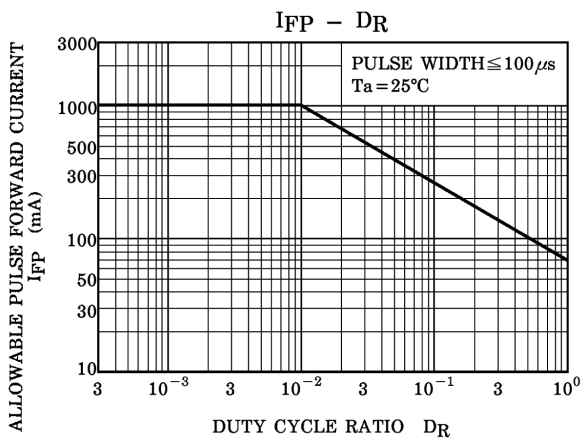
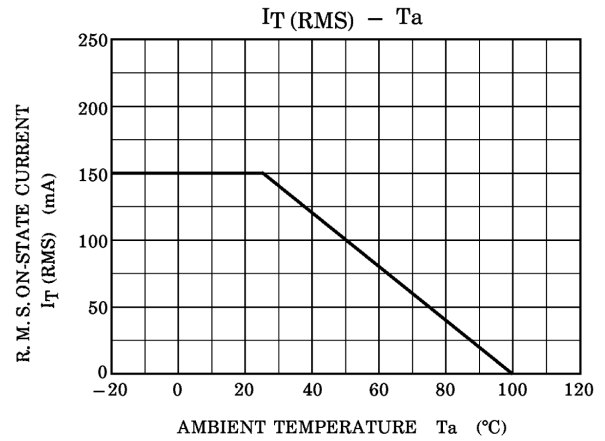
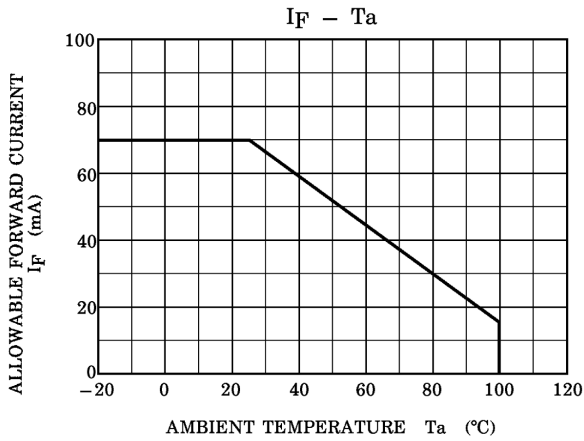

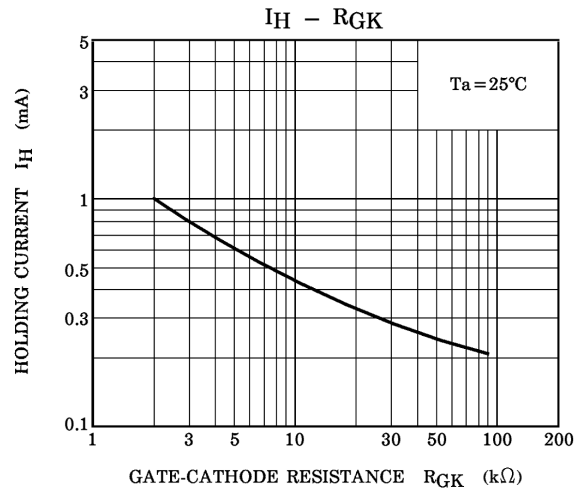
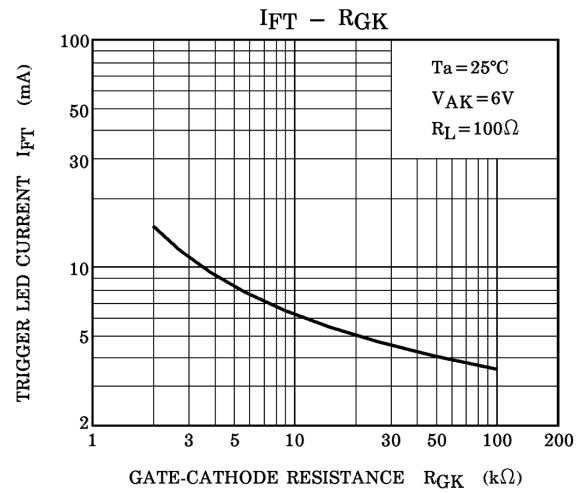
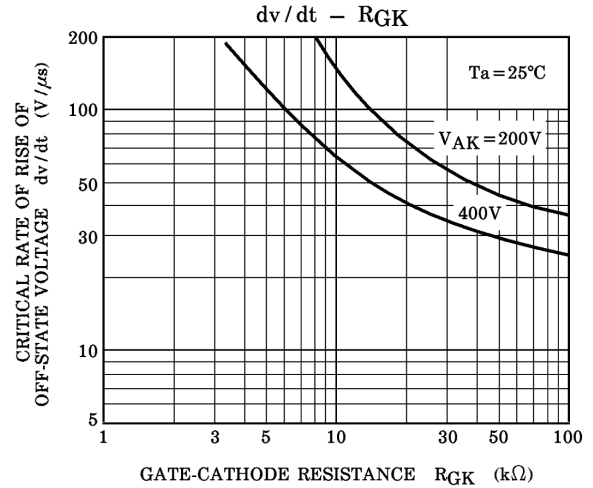
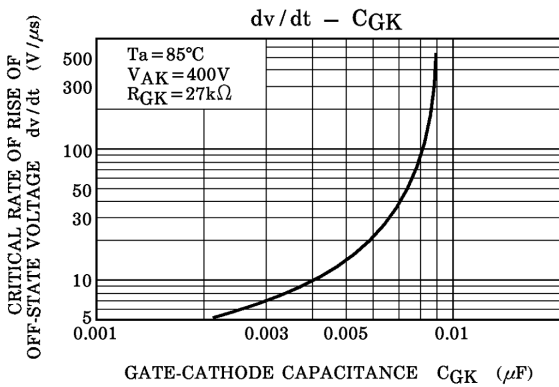
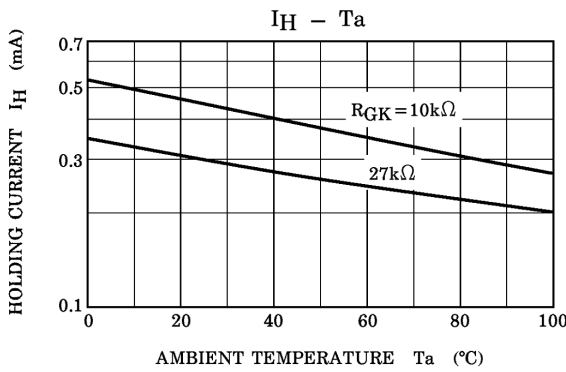
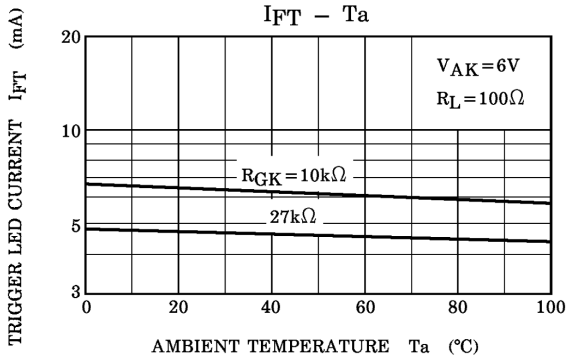
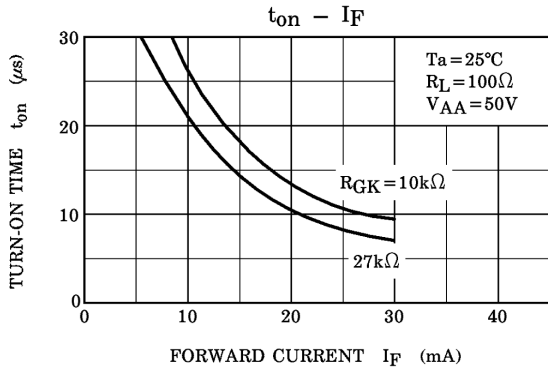

RESTRICTIONS ON PRODUCT USE

20070701-EN

- The information contained herein is subject to change without notice.
- TOSHIBA is continually working to improve the quality and reliability of its products. Nevertheless, semiconductor devices in general can malfunction or fail due to their inherent electrical sensitivity and vulnerability to physical stress. It is the responsibility of the buyer, when utilizing TOSHIBA products, to comply with the standards of safety in making a safe design for the entire system, and to avoid situations in which a malfunction or failure of such TOSHIBA products could cause loss of human life, bodily injury or damage to property.
In developing your designs, please ensure that TOSHIBA products are used within specified operating ranges as set forth in the most recent TOSHIBA products specifications. Also, please keep in mind the precautions and conditions set forth in the "Handling Guide for Semiconductor Devices," or "TOSHIBA Semiconductor Reliability Handbook" etc.
- The TOSHIBA products listed in this document are intended for usage in general electronics applications (computer, personal equipment, office equipment, measuring equipment, industrial robotics, domestic appliances, etc.). These TOSHIBA products are neither intended nor warranted for usage in equipment that requires extraordinarily high quality and/or reliability or a malfunction or failure of which may cause loss of human life or bodily injury ("Unintended Usage"). Unintended Usage include atomic energy control instruments, airplane or spaceship instruments, transportation instruments, traffic signal instruments, combustion control instruments, medical instruments, all types of safety devices, etc.. Unintended Usage of TOSHIBA products listed in this document shall be made at the customer's own risk.
- The products described in this document shall not be used or embedded to any downstream products of which manufacture, use and/or sale are prohibited under any applicable laws and regulations.
- The information contained herein is presented only as a guide for the applications of our products. No responsibility is assumed by TOSHIBA for any infringements of patents or other rights of the third parties which may result from its use. No license is granted by implication or otherwise under any patents or other rights of TOSHIBA or the third parties.
- GaAs(Gallium Arsenide) is used in this product. The dust or vapor is harmful to the human body. Do not break, cut, crush or dissolve chemically.
- Please contact your sales representative for product-by-product details in this document regarding RoHS compatibility. Please use these products in this document in compliance with all applicable laws and regulations that regulate the inclusion or use of controlled substances. Toshiba assumes no liability for damage or losses occurring as a result of noncompliance with applicable laws and regulations.