



PJU7NA60 / PJD7NA60 / PJP7NA60 / PJF7NA60

600V N-Channel MOSFET

Voltage

600 V

Current

7 A

Features

- $R_{DS(ON)}, V_{GS}@10V, I_D@3.5A < 1.2\Omega$
- High switching speed
- Improved dv/dt capability
- Low Gate Charge
- Low reverse transfer capacitance
- Lead free in compliance with EU RoHS 2.0
- Green molding compound as per IEC 61249 standard

Mechanical Data

- Case : TO-251AA, TO-252AA, TO-220AB, ITO-220AB-F Package
- Terminals : Solderable per MIL-STD-750, Method 2026
- TO-251AA Approx. Weight : 0.0104 ounces, 0.297grams
- TO-252AA Approx. Weight : 0.0104 ounces, 0.297grams
- TO-220AB Approx. Weight : 0.067 ounces, 1.9 grams
- ITO-220AB-F Approx. Weight : 0.068 ounces, 2 grams

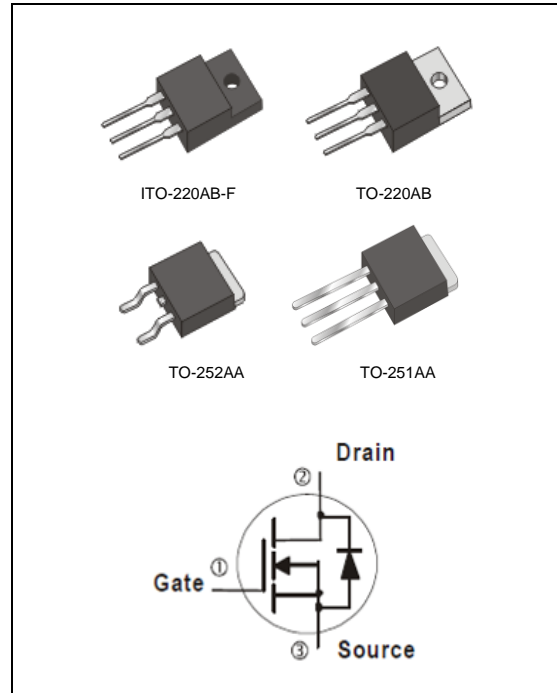

Maximum Ratings and Thermal Characteristics ($T_A=25^\circ\text{C}$ unless otherwise noted)

PARAMETER		SYMBOL	TO-251AA	TO-220AB	ITO-220AB-F	TO-252AA	UNITS
Drain-Source Voltage		V_{DS}	600				V
Gate-Source Voltage		V_{GS}	±30				
Continuous Drain Current ^(Note 4)		I_D	7				A
Pulsed Drain Current		I_{DM}	28				
Single Pulse Avalanche Energy ^(Note 1)		E_{AS}	489				mJ
Power Dissipation	$T_C=25^\circ\text{C}$	P_D	140	145	45	140	W
	Derate above 25°C		1.12	1.16	0.36	1.12	W/ $^\circ\text{C}$
Operating Junction and Storage Temperature Range		T_J, T_{STG}	-55~150				$^\circ\text{C}$
Typical Thermal Resistance ^(Note 4)							
- Junction to Case		$R_{\theta JC}$	0.89	0.88	2.78	0.89	$^\circ\text{C/W}$
- Junction to Ambient		$R_{\theta JA}$	110	62.5	120	110	

- Limited only By Maximum Junction Temperature



PJU7NA60 / PJD7NA60 / PJP7NA60 / PJF7NA60

Electrical Characteristics ($T_A=25^\circ\text{C}$ unless otherwise noted)

PARAMETER	SYMBOL	TEST CONDITION	MIN.	TYP.	MAX.	UNITS
Static						
Drain-Source Breakdown Voltage	BV_{DSS}	$V_{GS}=0V, I_D=250\mu A$	600	-	-	V
Gate Threshold Voltage	$V_{GS(th)}$	$V_{DS}=V_{GS}, I_D=250\mu A$	2	3.2	4	
Drain-Source On-State Resistance	$R_{DS(on)}$	$V_{GS}=10V, I_D=3.5A$	-	1.02	1.2	Ω
Zero Gate Voltage Drain Current	I_{DSS}	$V_{DS}=600V, V_{GS}=0V$	-	-	1	μA
Gate-Source Leakage Current	I_{GSS}	$V_{GS}=\pm 30V, V_{DS}=0V$	-	-	± 100	nA
Diode Forward Voltage	V_{SD}	$I_S=7A, V_{GS}=0V$	-	0.86	1.4	V
Dynamic (Note 5)						
Total Gate Charge	Q_g	$V_{DS}=480V, I_D=7A,$ $V_{GS}=10V$ (Note 2,3)	-	15.2	-	nC
Gate-Source Charge	Q_{gs}		-	5	-	
Gate-Drain Charge	Q_{gd}		-	4.8	-	
Input Capacitance	C_{iss}	$V_{DS}=25V, V_{GS}=0V,$ $f=1\text{MHZ}$	-	723	-	pF
Output Capacitance	C_{oss}		-	105	-	
Reverse Transfer Capacitance	C_{rss}		-	2	-	
Turn-On Delay Time	$t_{d(on)}$	$V_{DD}=300V, I_D=7A,$ $R_G=25\Omega$ (Note 2,3)	-	28	-	ns
Turn-On Rise Time	t_r		-	58	-	
Turn-Off Delay Time	$t_{d(off)}$		-	42	-	
Turn-Off Fall Time	t_f		-	31	-	
Drain-Source Diode						
Maximum Continuous Drain-Source Diode Forward Current	I_S	---	-	-	7	A
Maximum Pulsed Drain-Source Diode Forward Current	I_{SM}	---	-	-	28	
Reverse Recovery Time	t_{rr}	$V_{GS}=0V, I_S=7A$	-	350	-	ns
Reverse Recovery Charge	Q_{rr}	$di_f/dt=100A/\mu s$ (Note 2)	-	3.1	-	μC

NOTES :

1. $L=30\text{mH}, I_{AS}=5.5A, V_{DD}=50V, R_G=25\text{ohm}$, Starting $T_J=25^\circ\text{C}$
2. Pulse width $\leq 300\mu s$, Duty cycle $\leq 2\%$.
3. Essentially independent of operating temperature typical characteristics.
4. The maximum current rating is package limited.
5. Guaranteed by design, not subject to production testing.



PJU7NA60 / PJD7NA60 / PJP7NA60 / PJF7NA60

TYPICAL CHARACTERISTIC CURVES

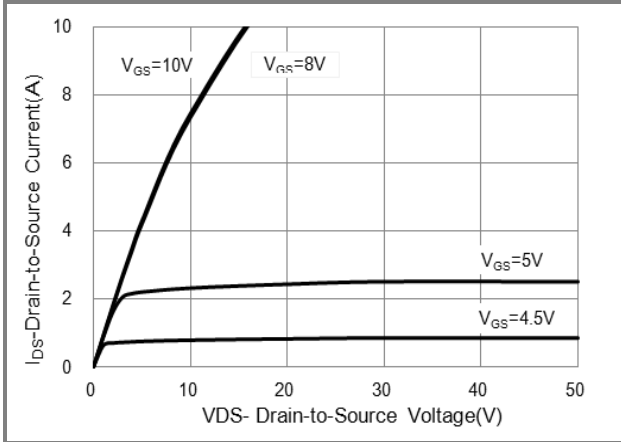

Fig.1 Output Characteristics

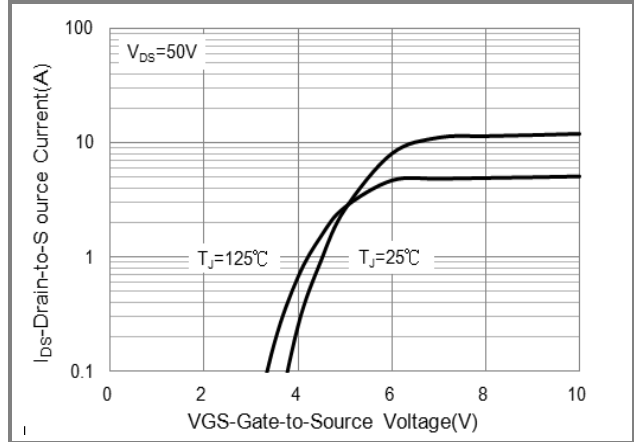

Fig.2 Transfer Characteristics

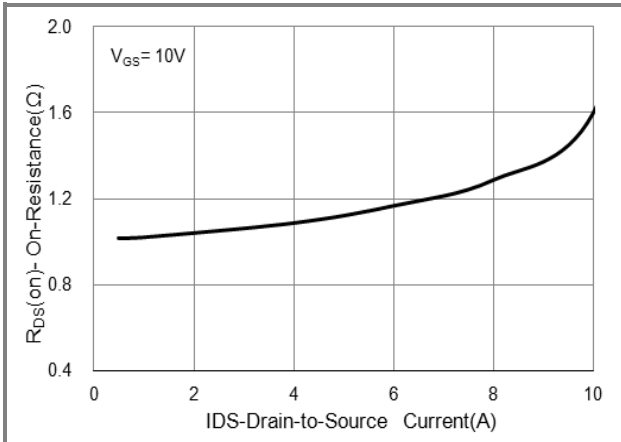

Fig.3 On-Resistance vs. Drain Current

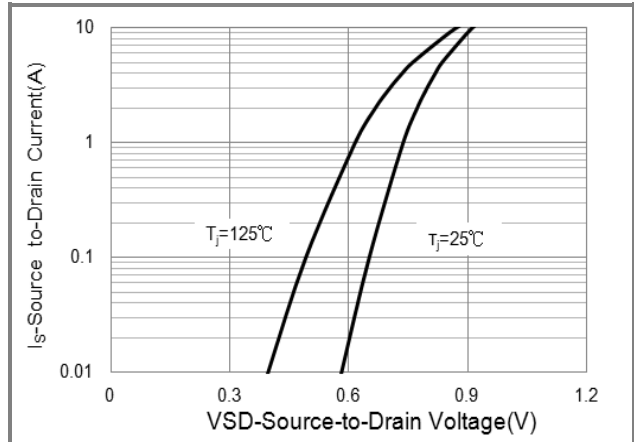

Fig.4 Source-Drain Diode Forward Voltage

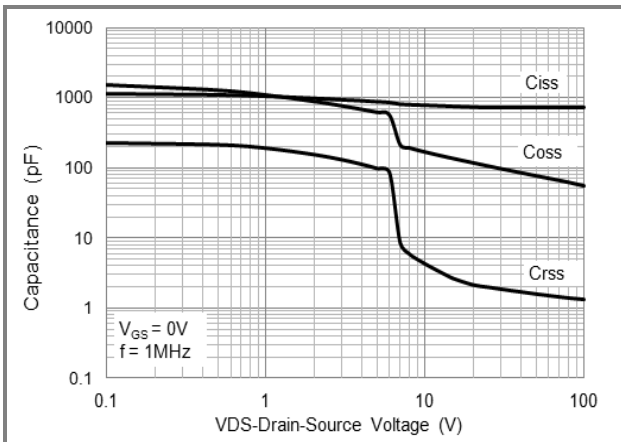

Fig.5 Capacitance vs. Drain-Source Voltage

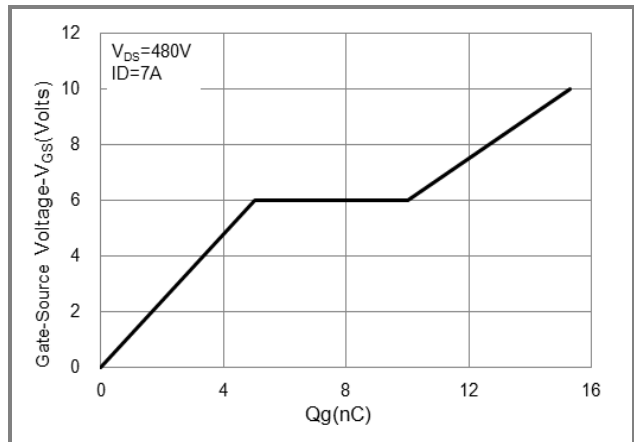

Fig.6 Gate Charge



PJU7NA60 / PJD7NA60 / PJP7NA60 / PJF7NA60

TYPICAL CHARACTERISTIC CURVES

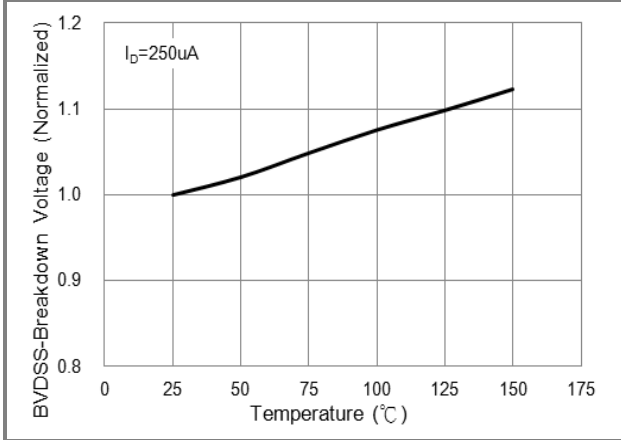

Fig.7 BV_{DSS} vs. Junction Temperature

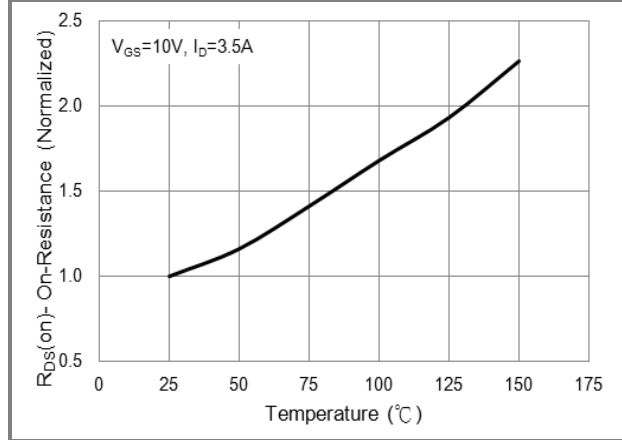

Fig.8 On-Resistance vs. Junction Temperature

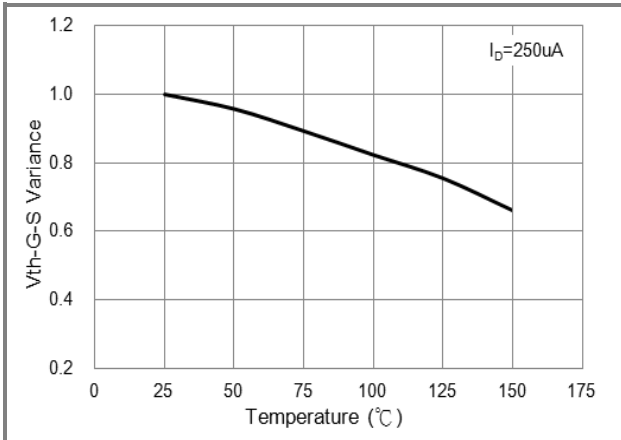

Fig.9 Threshold Voltage Variation with Temperature

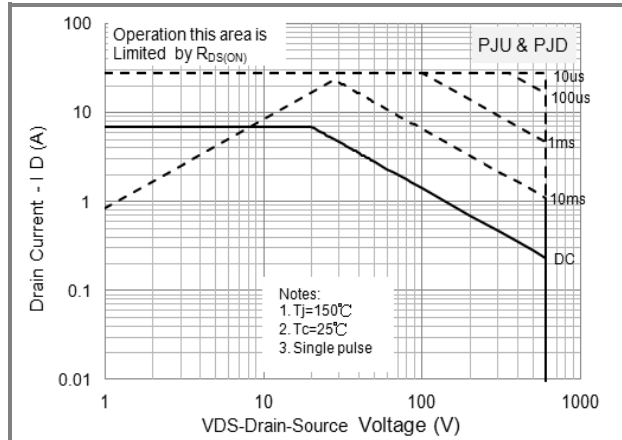

Fig.10 Maximum Safe Operating Area

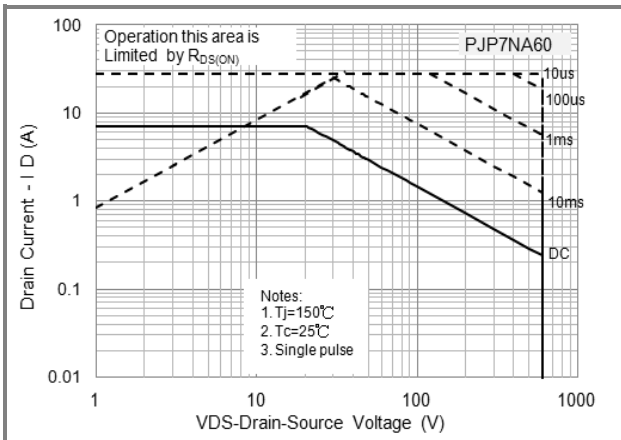

Fig.11 Maximum Safe Operating Area

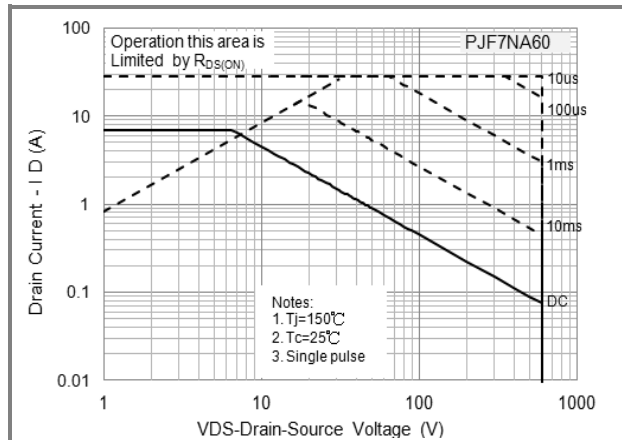

Fig.12 Maximum Safe Operating Area



PJU7NA60 / PJD7NA60 / PJP7NA60 / PJF7NA60

TYPICAL CHARACTERISTIC CURVES

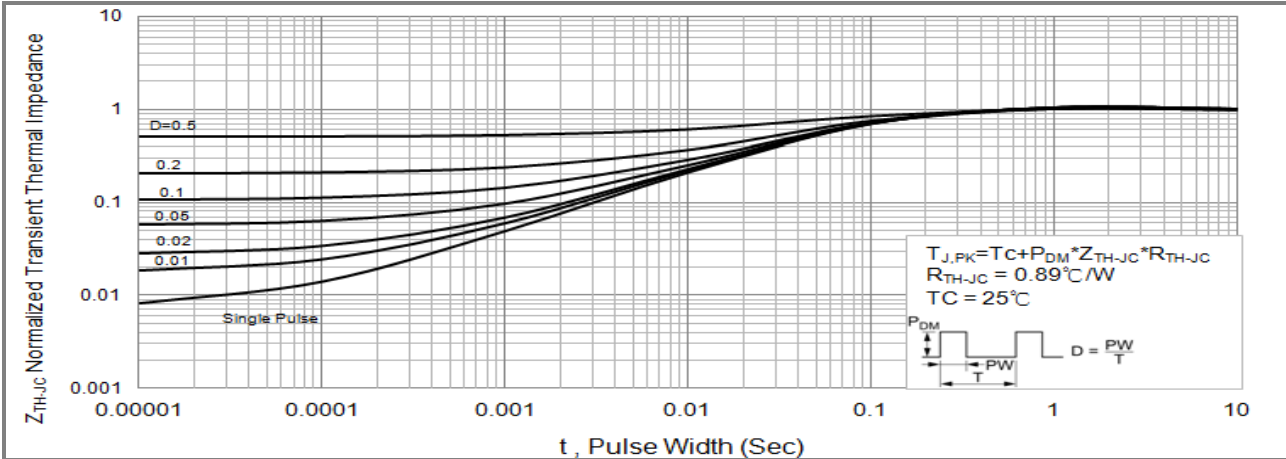

Fig.13 PJU/PJD Normalized Transient Thermal Impedance vs. Pulse Width

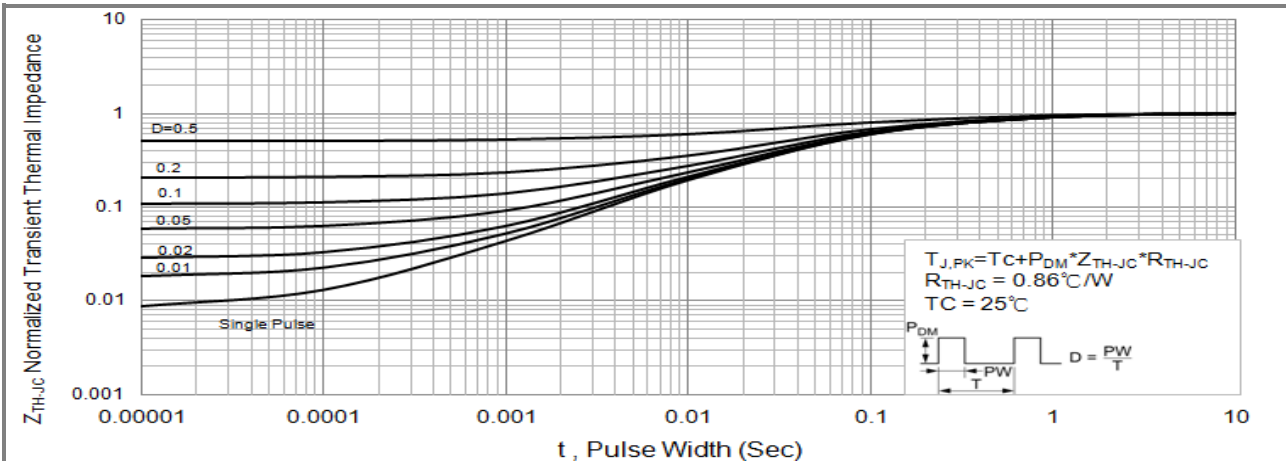

Fig.14 PJP7NA60 Normalized Transient Thermal Impedance vs. Pulse Width

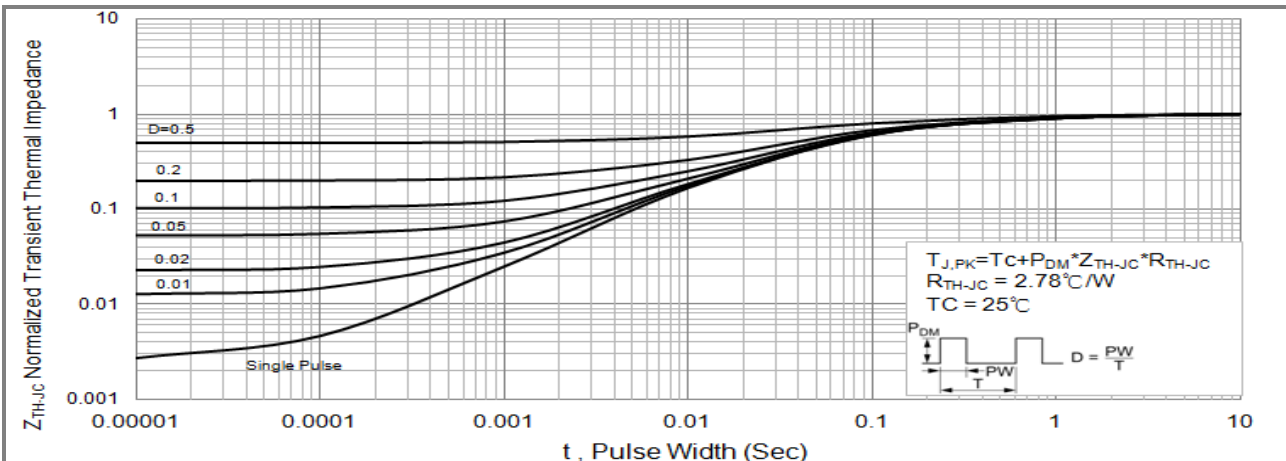

Fig.15 PJF7NA60 Normalized Transient Thermal Impedance vs. Pulse Width



PJU7NA60 / PJD7NA60 / PJP7NA60 / PJF7NA60

Packaging Information

ITO-220AB-F Dimension

Unit: inch(mm)

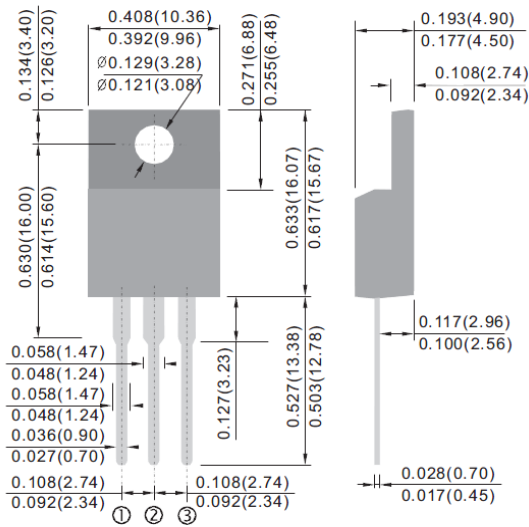

TO-220AB Dimension

Unit: inch(mm)

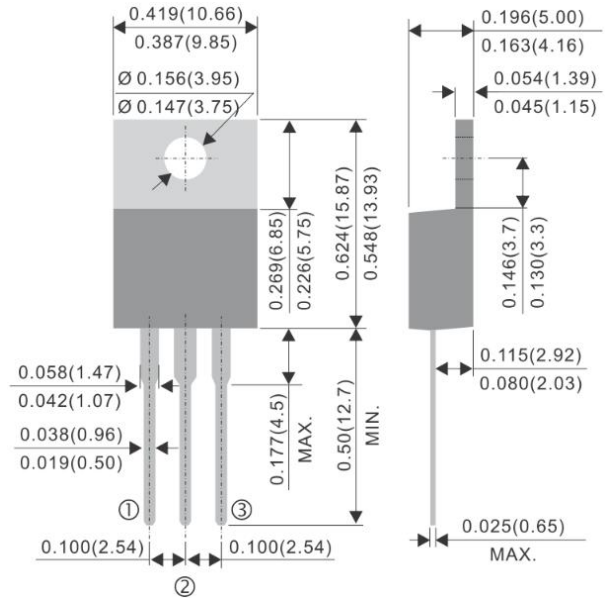

TO-252AA Dimension

Unit: inch(mm)

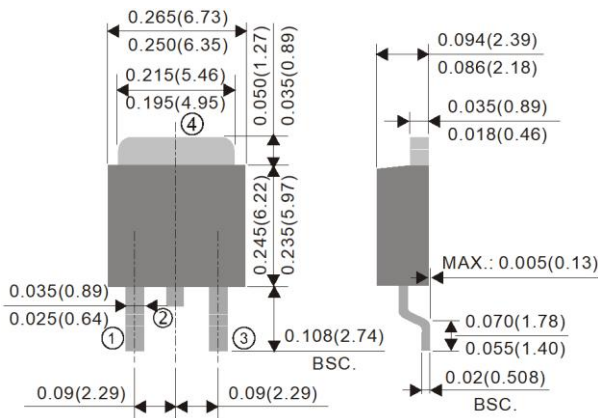

TO-251AA Dimension

Unit: inch(mm)

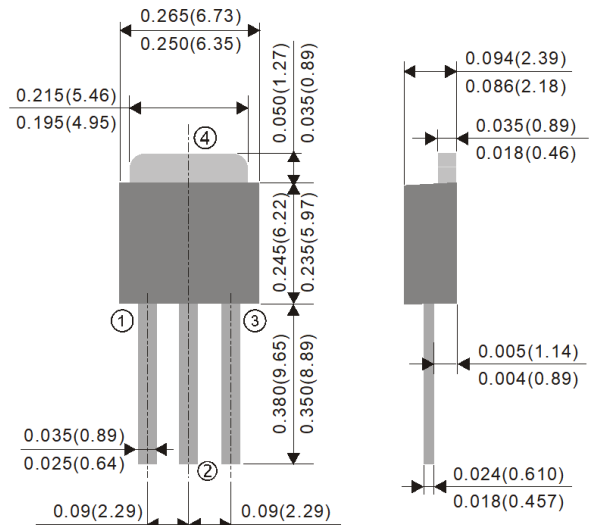



PJU7NA60 / PJD7NA60 / PJP7NA60 / PJF7NA60

Part No Packing Code Version

Part No Packing Code	Package Type	Packing Type	Marking	Version
PJU7NA60_T0_00001	TO-251AA	80pcs / Tube	U7NA60	Halogen free
PJD7NA60_L2_00001	TO-252AA	3,000pcs / 13" reel	D7NA60	Halogen free
PJP7NA60_T0_00001	TO-220AB	50pcs / Tube	P7NA60	Halogen free
PJF7NA60_T0_00001	ITO-220AB-F	50pcs / Tube	F7NA60	Halogen free

Mounting Pad Layout

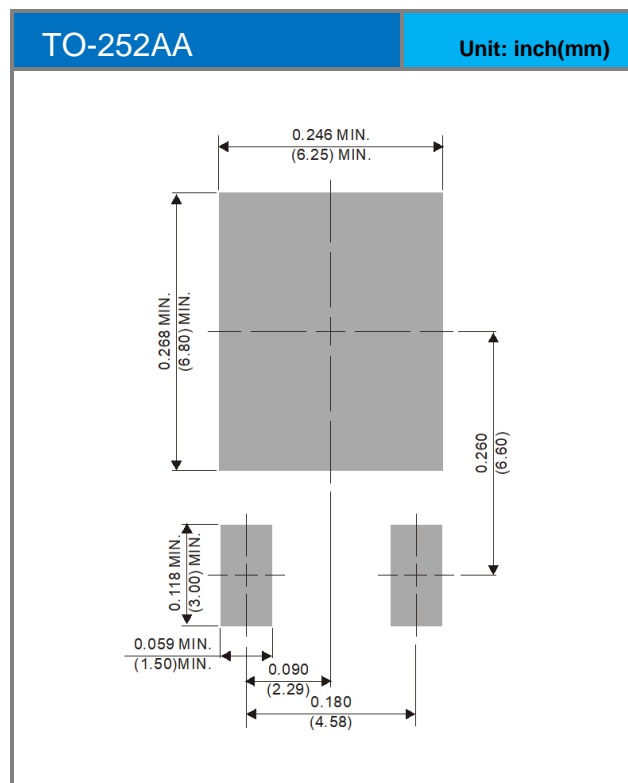



PJU7NA60 / PJD7NA60 / PJP7NA60 / PJF7NA60

Disclaimer

- Reproducing and modifying information of the document is prohibited without permission from Panjit International Inc..
- Panjit International Inc. reserves the rights to make changes of the content herein the document anytime without notification. Please refer to our website for the latest document.
- Panjit International Inc. disclaims any and all liability arising out of the application or use of any product including damages incidentally and consequentially occurred.
- Panjit International Inc. does not assume any and all implied warranties, including warranties of fitness for particular purpose, non-infringement and merchantability.
- Applications shown on the herein document are examples of standard use and operation. Customers are responsible in comprehending the suitable use in particular applications. Panjit International Inc. makes no representation or warranty that such applications will be suitable for the specified use without further testing or modification.
- The products shown herein are not designed and authorized for equipments requiring high level of reliability or relating to human life and for any applications concerning life-saving or life-sustaining, such as medical instruments, transportation equipment, aerospace machinery et cetera. Customers using or selling these products for use in such applications do so at their own risk and agree to fully indemnify Panjit International Inc. for any damages resulting from such improper use or sale.
- Since Panjit uses lot number as the tracking base, please provide the lot number for tracking when complaining.