

# Darlington

# 2SD2439

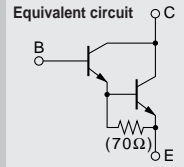

Silicon NPN Triple Diffused Planar Transistor (Complement to type 2SB1588)

Application : Audio, Series Regulator and General Purpose

**Absolute maximum ratings** (Ta=25°C)

Symbol	Ratings	Unit
V <sub>CB0</sub>	160	V
V <sub>CE0</sub>	150	V
V <sub>EB0</sub>	5	V
I <sub>C</sub>	10	A
I <sub>B</sub>	1	A
P <sub>C</sub>	80(T <sub>C</sub> =25°C)	W
T <sub>J</sub>	150	°C
T <sub>stg</sub>	-55 to +150	°C

**Electrical Characteristics** (Ta=25°C)

Symbol	Conditions	Ratings	Unit
I <sub>CB0</sub>	V <sub>CB</sub> =160V	100max	μA
I <sub>EB0</sub>	V <sub>EB</sub> =5V	100max	μA
V <sub>(BR)CEO</sub>	I <sub>C</sub> =30mA	150min	V
h <sub>FE</sub>	V <sub>CE</sub> =4V, I <sub>C</sub> =7A	5000min*	
V <sub>CE(sat)</sub>	I <sub>C</sub> =7A, I <sub>B</sub> =7mA	2.5max	V
V <sub>BE(sat)</sub>	I <sub>C</sub> =7A, I <sub>B</sub> =7mA	3.0max	V
f <sub>T</sub>	V <sub>CE</sub> =12V, I <sub>E</sub> =-2A	55typ	MHz
C <sub>OB</sub>	V <sub>CB</sub> =10V, f=1MHz	95typ	pF

\*h<sub>FE</sub> Rank  $\bar{O}$ (5000 to 12000), P(6500 to 20000), Y(15000 to 30000)

**External Dimensions FM100(TO3PF)**

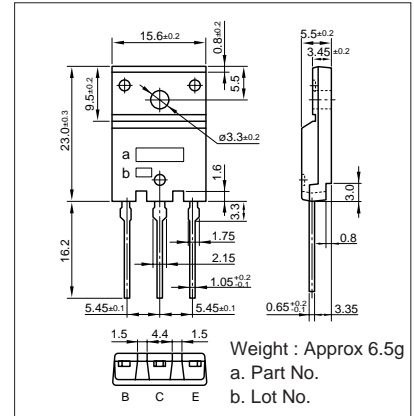

**Typical Switching Characteristics (Common Emitter)**

V <sub>CC</sub> (V)	R <sub>L</sub> (Ω)	I <sub>C</sub> (A)	V <sub>BB1</sub> (V)	V <sub>BB2</sub> (V)	I <sub>B1</sub> (mA)	I <sub>B2</sub> (mA)	t <sub>on</sub> (μs)	t <sub>stg</sub> (μs)	t <sub>f</sub> (μs)
70	10	7	10	-5	7	-7	0.5typ	10.0typ	1.1typ

**I<sub>C</sub>-V<sub>CE</sub> Characteristics (Typical)**

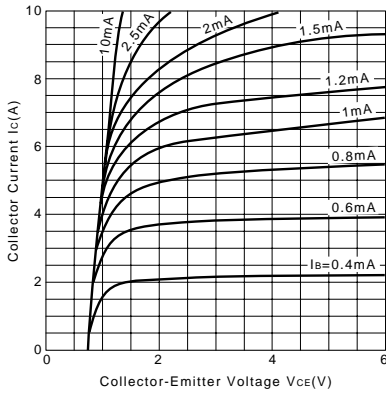

**V<sub>CE(sat)</sub>-I<sub>B</sub> Characteristics (Typical)**

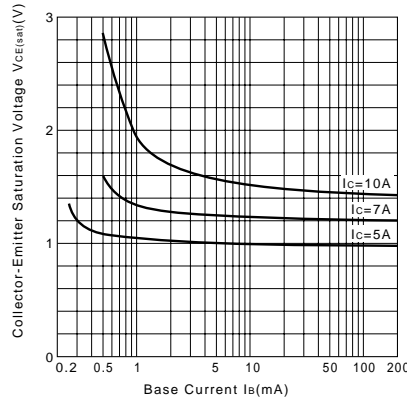

**I<sub>C</sub>-V<sub>BE</sub> Temperature Characteristics (Typical)**

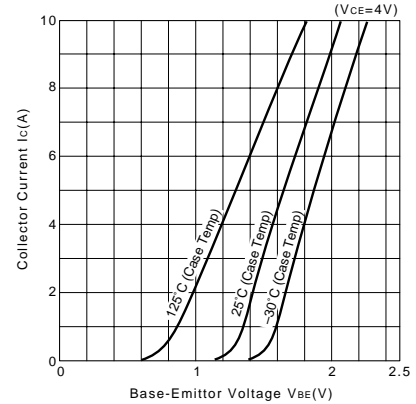

**h<sub>FE</sub>-I<sub>C</sub> Characteristics (Typical)**

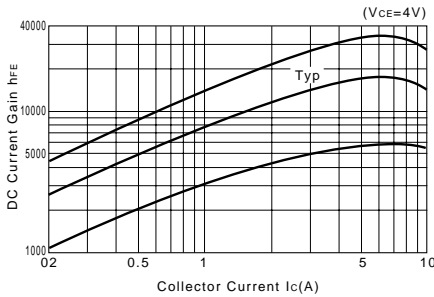

**h<sub>FE</sub>-I<sub>C</sub> Temperature Characteristics (Typical)**

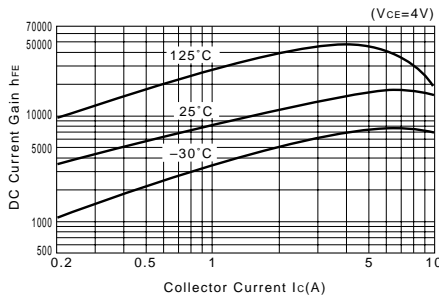

**θ<sub>j-a</sub>-t Characteristics**

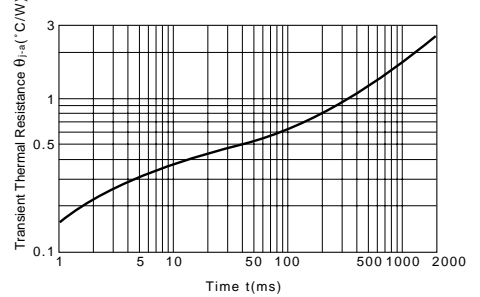

**f<sub>T</sub>-I<sub>E</sub> Characteristics (Typical)**

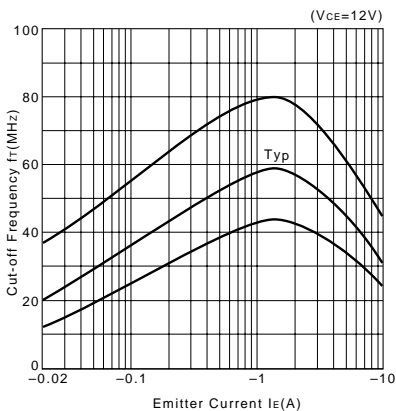

**Safe Operating Area (Single Pulse)**

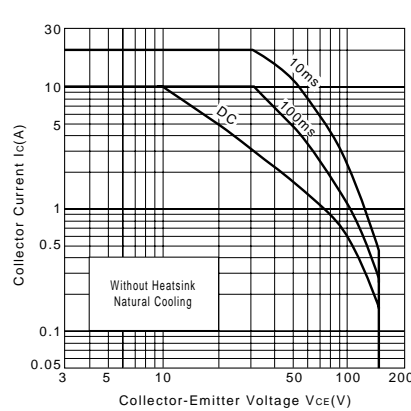

**P<sub>C</sub>-T<sub>a</sub> Derating**

