

**PHASE CONTROL SCR
TO-220 FULLPAK**

Description/Features

The 25TTS..FP **SAFEIR** series of silicon controlled rectifiers are specifically designed for medium power switching and phase control applications. The glass passivation technology used has reliable operation up to 125° C junction temperature.

Typical applications are in input rectification (soft start) and these products are designed to be used with International Rectifier input diodes, switches and output rectifiers which are available in identical package outlines.

Fully isolated package ($V_{INS} = 2500 V_{RMS}$)

UL E78996 approved 

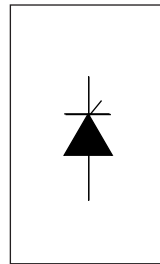

$V_T < 1.25V @ 16A$
 $I_{TSM} = 300A$
 $V_{RRM} 800 \text{ to } 1600V$

Output Current in Typical Applications

Applications	Single-phase Bridge	Three-phase Bridge	Units
Capacitive input filter $T_A = 55^\circ C, T_J = 125^\circ C$, common heatsink of $1^\circ C/W$	18	22	A

Major Ratings and Characteristics

Characteristics	25TTS..FP	Units
$I_{T(AV)}$ Sinusoidal waveform	16	A
I_{RMS}	25	A
V_{RRM}/V_{DRM}	upto 1600	V
I_{TSM}	300	A
$V_T @ 16A, T_J = 25^\circ C$	1.25	V
dv/dt	500	V/ μs
di/dt	150	A/ μs
T_J	-40 to 125	°C

Package Outline

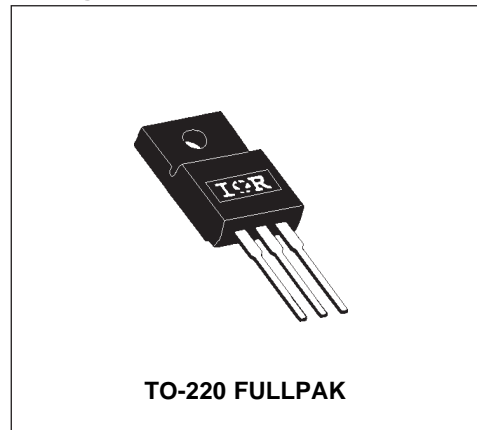

Voltage Ratings

Part Number	V_{RRM} , maximum peak reverse voltage V	V_{DRM} , maximum peak direct voltage V	I_{RRM}/I_{DRM} 125°C mA
25TTS08FP	800	800	10
25TTS12FP	1200	1200	
25TTS16FP	1600	1600	

Absolute Maximum Ratings

Parameters	25TTS..FP	Units	Conditions
$I_{T(AV)}$ Max. Average On-state Current	16	A	@ $T_c=85^\circ\text{C}$, 180° conduction half sine wave
I_{RMS} Max. RMS On-state Current	25		
I_{TSM} Max. Peak One Cycle Non-Repetitive Surge Current	300		10ms Sine pulse, rated V_{RRM} applied
	350	10ms Sine pulse, no voltage reapplied	
I^2t Max. I^2t for fusing	450	A^2s	10ms Sine pulse, rated V_{RRM} applied
	630		10ms Sine pulse, no voltage reapplied
$I^2\sqrt{t}$ Max. $I^2\sqrt{t}$ for fusing	6300	$A^2\sqrt{s}$	$t=0.1$ to 10ms , no voltage reapplied
V_{TM} Max. On-state Voltage Drop	1.25	V	@ 16A, $T_j = 25^\circ\text{C}$
r_t On-state slope resistance	12.0	$m\Omega$	$T_j = 125^\circ\text{C}$
$V_{T(TO)}$ Threshold Voltage	1.0	V	
$I_{RM/DM}$ Max. Reverse and Direct Leakage Current	0.5	mA	$T_j = 25^\circ\text{C}$
	10		$T_j = 125^\circ\text{C}$
I_H Holding Current	Typ.	mA	Anode Supply = 6V, Resistive load, Initial $I_T=1\text{A}$ 25TTS08FP, 25TTS12FP 25TTS16FP
	Max.		
	-		
	100		
	150		
I_L Max. Latching Current	200	mA	Anode Supply = 6V, Resistive load
dv/dt Max. Rate of Rise of off-state Voltage	500	$V/\mu s$	
di/dt Max. Rate of Rise of turned-on Current	150	$A/\mu s$	

Triggering

Parameters	25TTS..FP	Units	Conditions
P_{GM} Max. peak Gate Power	8.0	W	
$P_{G(AV)}$ Max. average Gate Power	2.0		
$+I_{GM}$ Max. peak positive Gate Current	1.5	A	
$-V_{GM}$ Max. peak negative Gate Voltage	10	V	
I_{GT} Max. required DC Gate Current to trigger	60	mA	Anode supply = 6V, resistive load, $T_J = -10^\circ\text{C}$
	45		Anode supply = 6V, resistive load, $T_J = 25^\circ\text{C}$
	20		Anode supply = 6V, resistive load, $T_J = 125^\circ\text{C}$
V_{GT} Max. required DC Gate Voltage to trigger	2.5	V	Anode supply = 6V, resistive load, $T_J = -10^\circ\text{C}$
	2.0		Anode supply = 6V, resistive load, $T_J = 25^\circ\text{C}$
	1.0		Anode supply = 6V, resistive load, $T_J = 125^\circ\text{C}$
V_{GD} Max. DC Gate Voltage not to trigger	0.25		$T_J = 125^\circ\text{C}$, $V_{DRM} = \text{rated value}$
I_{GD} Max. DC Gate Current not to trigger	2.0	mA	$T_J = 125^\circ\text{C}$, $V_{DRM} = \text{rated value}$

Switching

Parameters	25TTS..FP	Units	Conditions
t_{gt} Typical turn-on time	0.9	μs	$T_J = 25^\circ\text{C}$
t_{rr} Typical reverse recovery time	4		$T_J = 125^\circ\text{C}$
t_q Typical turn-off time	110		

Thermal-Mechanical Specifications

Parameters	25TTS..FP	Units	Conditions
T_J Max. Junction Temperature Range	-40 to 125	$^\circ\text{C}$	
T_{stg} Max. Storage Temperature Range	-40 to 125		
R_{thJC} Max. Thermal Resistance Junction to Case	1.5	$^\circ\text{C/W}$	DCoperation
R_{thJA} Max. Thermal Resistance Junction to Ambient	62		
R_{thCS} Typ. Thermal Resistance Case to Heatsink	1.5		Mounting surface, smooth and greased
wt Approximate Weight	2 (0.07)	g (oz.)	
T Mounting Torque	Min.	6 (5)	Kg-cm (lbf-in)
	Max.	12 (10)	
Case Style	TO-220FULLPAK		(94/V0)

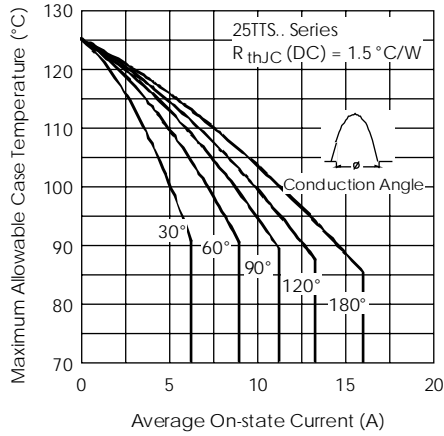

Fig. 1 - Current Rating Characteristics

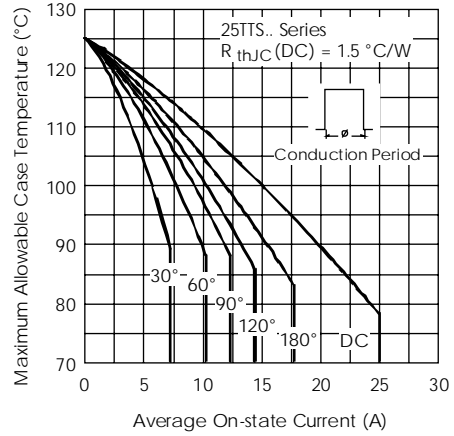

Fig. 2 - Current Rating Characteristics

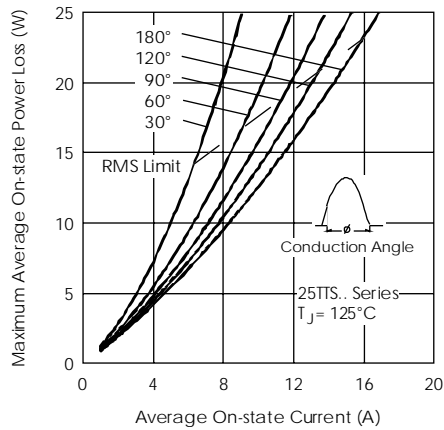

Fig. 3 - On-state Power Loss Characteristics

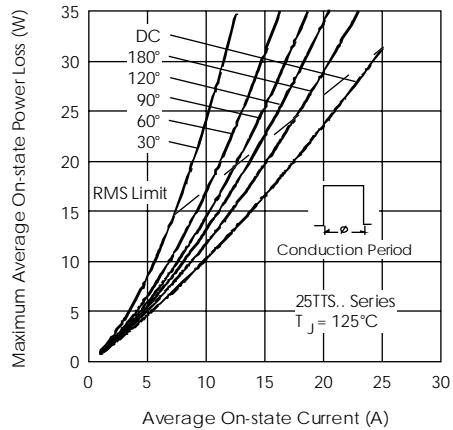

Fig. 4 - On-state Power Loss Characteristics

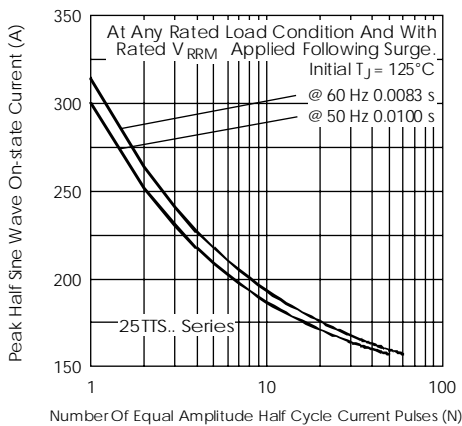

Fig. 5 - Maximum Non-Repetitive Surge Current

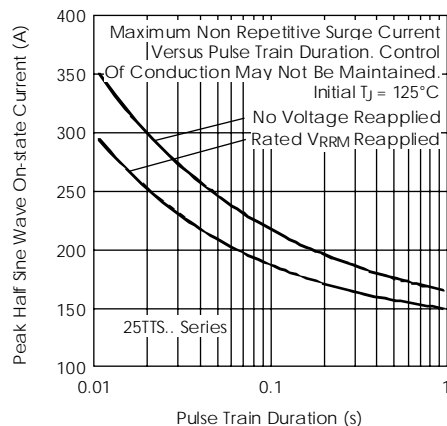

Fig. 6 - Maximum Non-Repetitive Surge Current

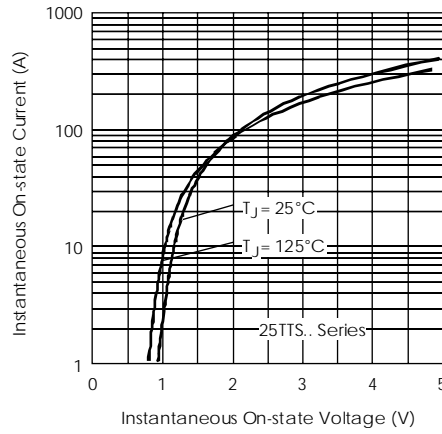

Fig. 7 - On-state Voltage Drop Characteristics

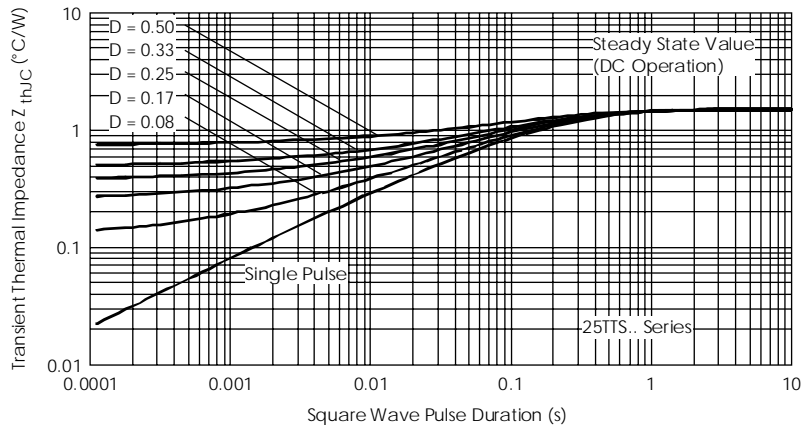

Fig. 8 - Thermal Impedance Z_{thJC} Characteristics

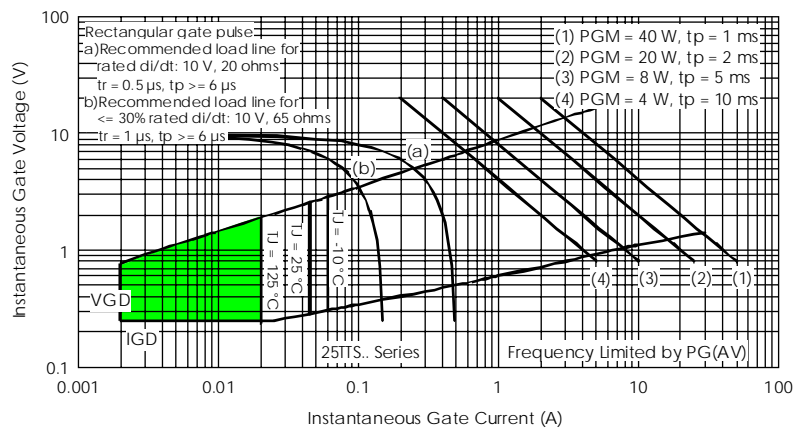

Fig. 9 - Gate Characteristics

25TTS..FP SAFEIR Series

Bulletin I2135 rev. D 03/99

International
IR Rectifier

Outline Table

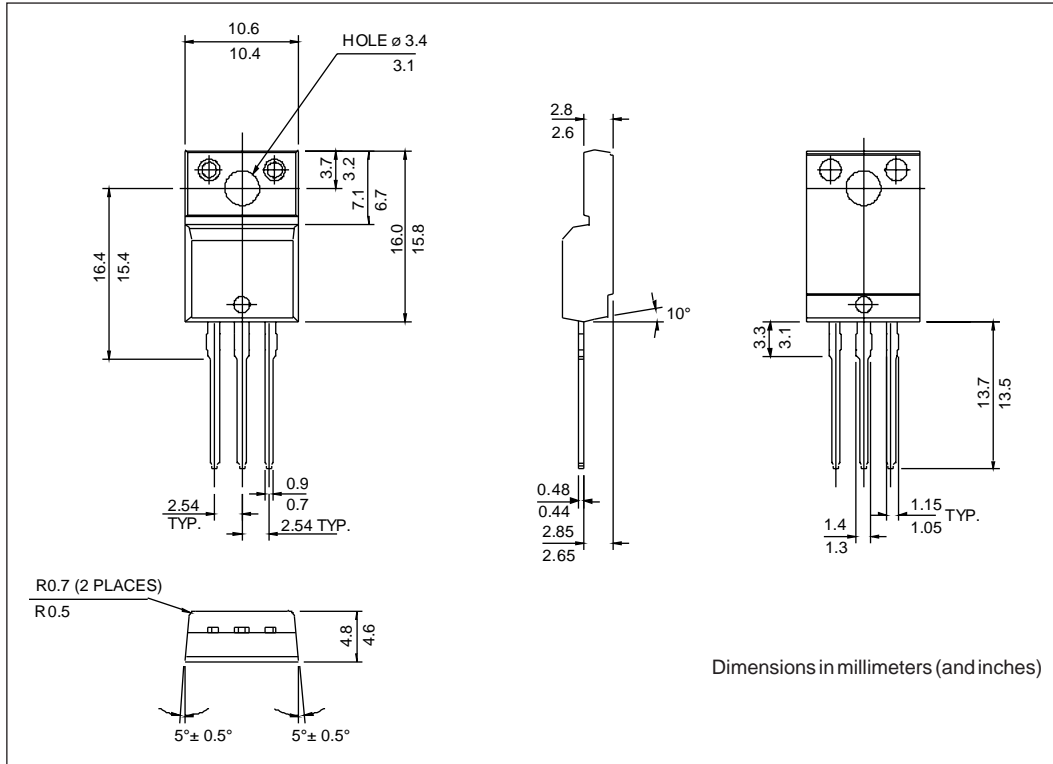

Ordering Information Table

